

1. 尺寸: Dimensions; Unit: mm

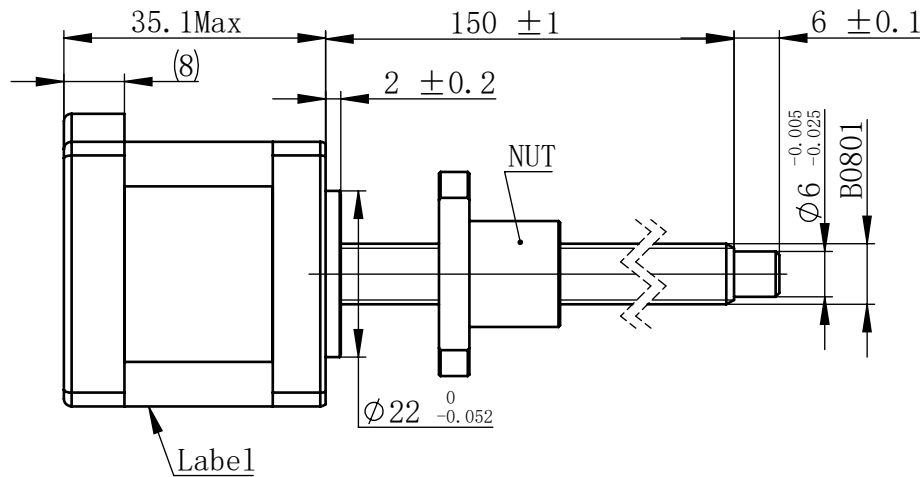

2. 接线图 Wiring Diagram

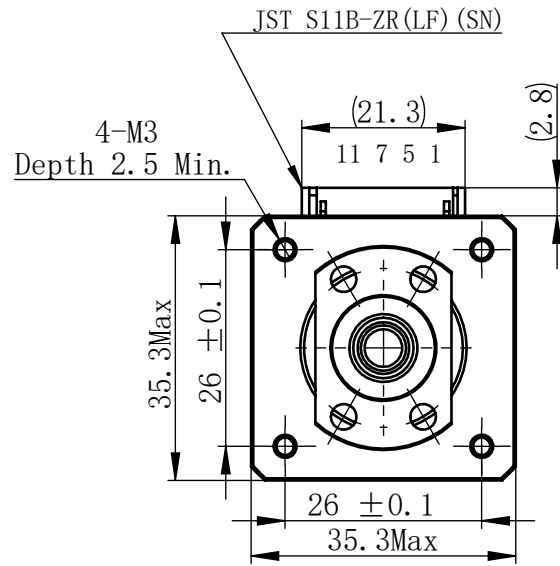
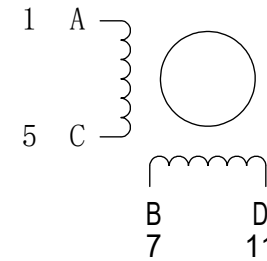

3. 励磁顺序 vs. 旋转方向
Exciting Sequence vs. Direction of Rotation

STEP	A	B	C	D	CCW
1	+	+	-	-	↑
2	-	+	+	-	
3	-	-	+	+	
4	+	-	-	+	

↓ CW

从安装面看为顺时针方向
Clockwise view from mounting side

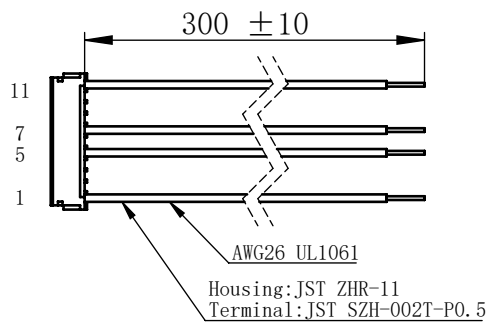

连接器针位 vs. 引线颜色
Pin No. vs. Lead Wire Colour

Pin No.	颜色 Colour
1	黑 BLK
5	绿 GRN
7	红 RED
11	蓝 BLU

Nut

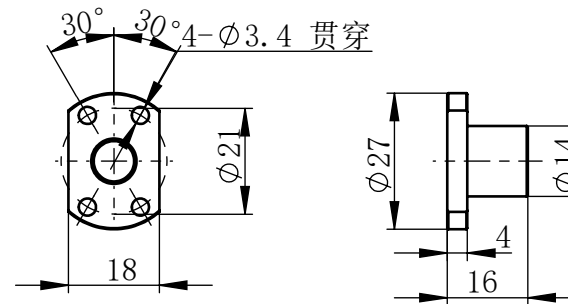

4. 电机标签 Motor label

MOONS' BALL SCREW MOTOR
BE143S-B0801-150-A1P-S-150
XXXXXXXXXX

批次号

技术要求:

- 未注尺寸公差参照GB/T 1804-M;
- 丝杠和螺母配对使用, 运行流畅不卡顿, 无异音;
- 丝杠表面无擦伤, 锈斑等不良;
- 螺母安装方向与图中保持一致。

未标注线性尺寸和公差
Tolerance for linear and dimensions
without individual tolerance indications
GB/T 1804-M eqv ISO 2768-1:M

未标注形状与位置尺寸公差
Geometrical tolerance for features
without individual tolerance indications
GB/T 1184-K eqv ISO 2768-2:K

设计 Design	母飞翔	2024/12/29
校核 Check		
工艺 Process		
标准化 Standard		
批准 Approve		

材料 Material	总图
Page 1 of 2	

比例 Scale	零件名 Part Name	直线步进电机
	型号 Model NO.	BE143S-B0801-150-A1P-S-150
版本 Version	物料号 Material NO.	4611230001897

版本变更

版本	变更说明	签名	日期
A0	初始版本	母飞翔	2024/12/26

I. 请避免螺母脱离丝杠
Keep nut on screw.

II. 非专业人士请勿拆解电机
Avoid disassembly without qualification.

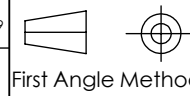

上海市闵行区
鸣嘉路168号
(021)52634688

产品规格书 Specification

5. 参数规格: Technique Parameter:



参数表 Parameter List	
相数 Number Of Phase	2
步长 Linear Travel/Step	0.005 mm (1.8°)
额定电压 Rated Voltage	2.4 V DC
额定电流 Rated Current	1.5 Amp
额定推力 Rated Thrust	200 N(@300rpm, rated current)
相电阻 Phase Resistance	1.61 ohm±15% (20°C)
相电感 Phase Inductance	2.5 mH±20% (1kHz 1V rms)
转子惯量 Rotor Inertia	20 gcm ²
重量 Weight	0.21 Kg
绝缘等级 Insulation Class	B(130°C)
丝杠直径 Screw Diameter	8 mm
丝杠导程 Lead	1 mm
旋向 Direction of thread	右旋RH
精度等级 Accuracy level	C7
轴向间隙 Axial clearance	±0.02mm

7. 注意事项: Note:

- 丝杠不得承受径向负载, 不能夹装或者硬物敲击;
The screw cannot bear radial load, and it cannot be subjected to clamping or hard object striking.
- 丝杠和螺母配对使用, 请勿自行拆卸, 如有需求请与厂商联系;
Screw and nut should be paired in use, Please do not disassemble it yourself. If necessary, please contact the manufacturer;
- 丝杠已涂覆专用油脂, 如有加脂需求, 请与厂商联系;
The screw have been coated with special lubricant. If you need to add lubricant, please contact the manufacturer.
- 使用时避免油污、切削液、过多粉尘、腐蚀性或可燃性气体和液体等特殊环境;
Avoid special environments. Such as: oil pollution、cutting fluid、excessive dust、corrosive, or flammable gases and liquids during operating.
- 工作温度: -20~60°C (不结冰, 不结露),
储存温度: -20~80°C (不结冰, 不结露)
如有特殊需求, 请与厂商联系;
Operating temperature: -20~60°C (no freezing, no condensation),
Storage temperature: -20~80°C (no freezing, no condensation)
Please contact the manufacturer if you have special requirements.
- 建议保养时间每三个月/半年一次, 具体时间请根据工况调整。
Suggested maintenance time: every 3 months/6 months, specific time should be adjusted according to the working conditions.

6. 特殊特性: Special Characteristics:

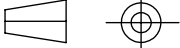
1. 无

版本变更				未标注线性尺寸和公差 Tolerance for linear and dimensions without individual tolerance indications GB/T 1804-M eqv ISO 2768-1:M	设计 Design	母飞翔	2024/12/29	 First Angle Method	 MOONS' moving in better ways	上海市闵行区 鸣嘉路168号 (021)52634688
版本	变更说明	签名	日期							
A0	初始版本	母飞翔	2024/12/26	未标注形状与位置尺寸公差 Geometrical tolerance for features without individual tolerance indications GB/T 1184-K eqv ISO 2768-2:K	工艺 Process				2:3	直线步进电机
				I. 请避免螺母脱离丝杠 Keep nut on screw.	标准化 Standard				型号 Model NO.	BE143S-B0801-150-A1P-S-150
				II. 非专业人士请勿拆解电机 Avoid disassembly without qualification.	批准 Approve			Page 2 of 2	版本 Version	A0
									物料号 Material NO.	4611230001897